

Micro-TX 全制式通信矢量信号源



产品概述

Micro-TX

性能特点

-
- GSM/EDGE/TD-SCDMA/WCDMA/TDD-LTE/
FDD-LTE/NB-IoT/LoRa
- BPSK/QPSK/OQPSK/8PSK/16QAM/32QAM/64QAM/128Q
AM/256QAM/MSK/FSK
- 20MHz 100MHz
-
- 10MHz 6000MHz
- 190*93*32mm 0.8kg
- USB



功能及应用

功能

模拟调制

Micro-TX AMFMMPM

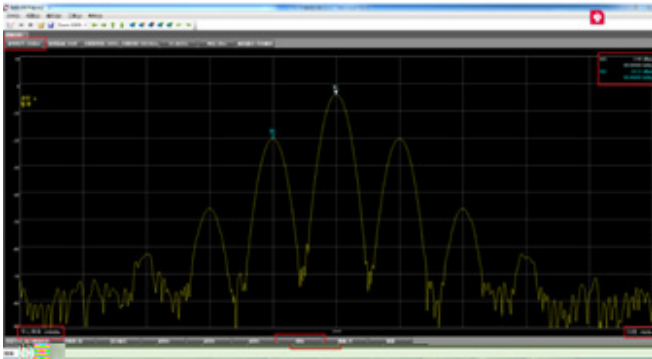

数字调制

Micro-TX

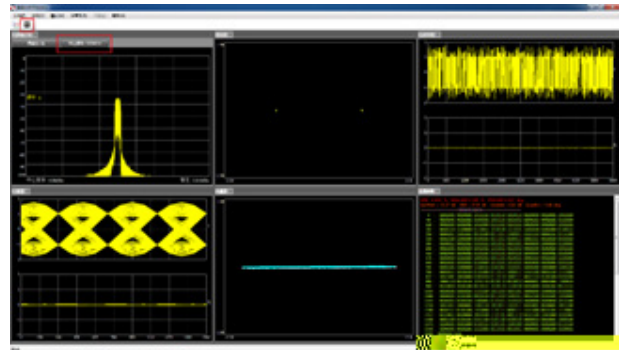

标准通信制式

Micro-TX



ARB 功能

ARB

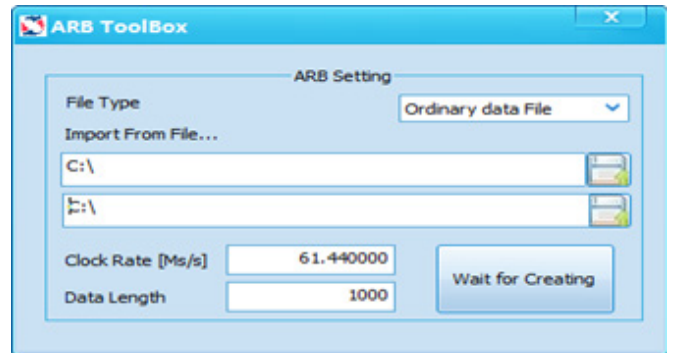

脉冲调制

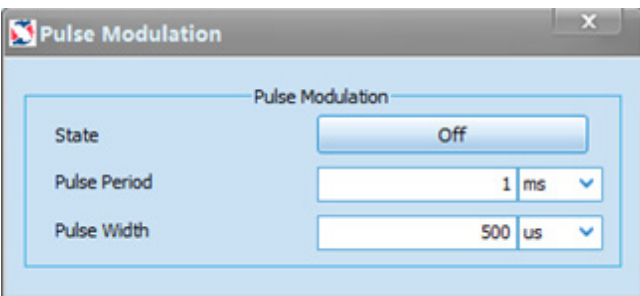

扫频模式

Micro-TX

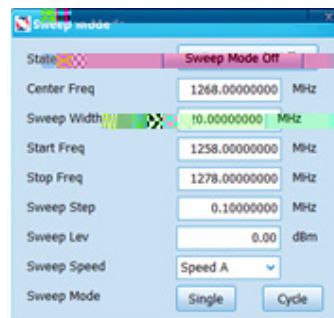

良好的相位噪声

Micro-TX 10kHz
-105dBc -110dBc

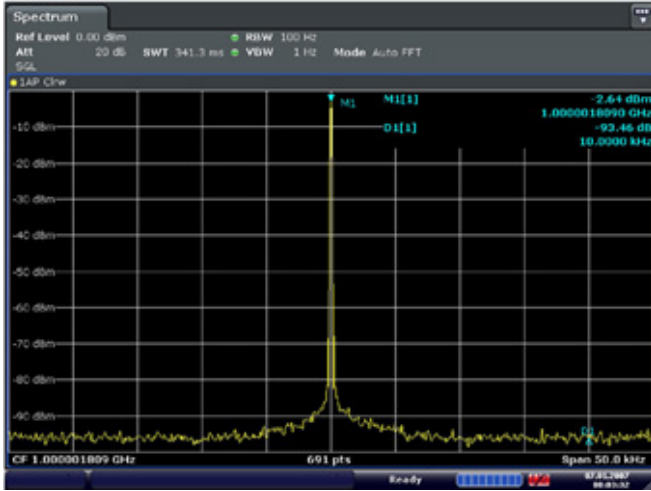

动态范围

Micro-TX
-110dBm +14dBm

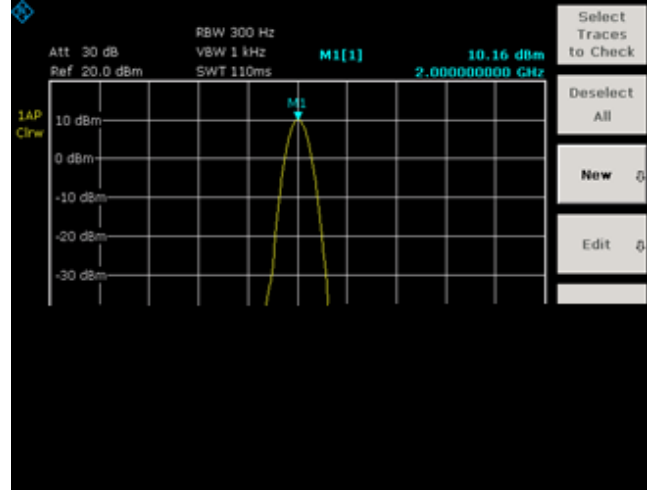

应用

实验室射频测试

Micro-TX 10MHz 6GHz
10kHz -105dBc
Micro-TX

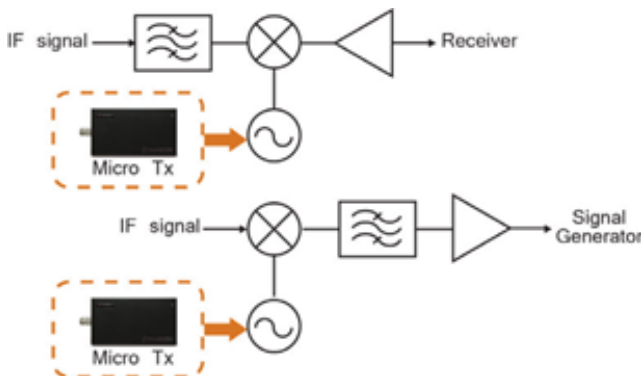

Micro-TX 替代本振

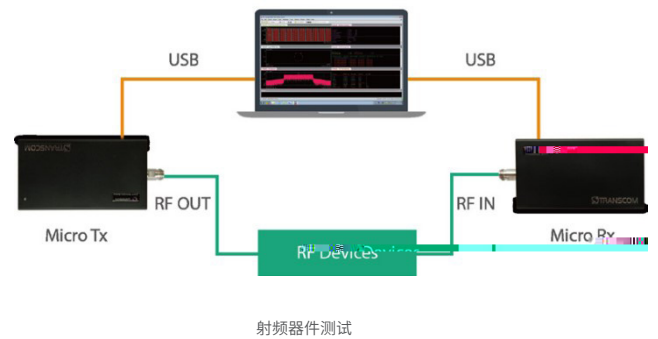

射频器件测试

Micro-TX 全制式通信矢量信号源

制造业应用

Micro-TX
TDD-LTE/FDD-LTE/NB-IoT/LoRa

GSM/EDGE/TD-SCDMA/WCDMA/

Micro-RX

教学应用

Micro-TX

Micro-RX

Micro-TX

Micro-TX

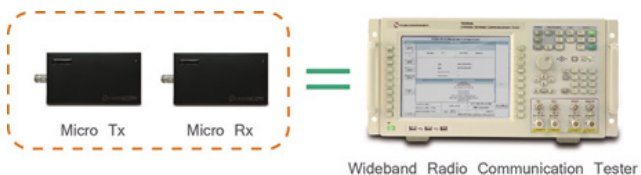

制造业终端测试应用

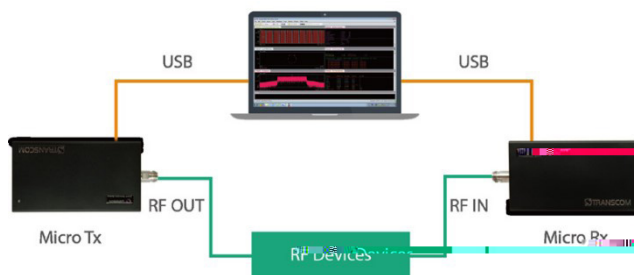

射频微波教学测试应用



制造业基站测试应用

产品特点

快速部署

190*93*32mm

0.8kg

系统集成及二次开发

" Micro-Tx

API

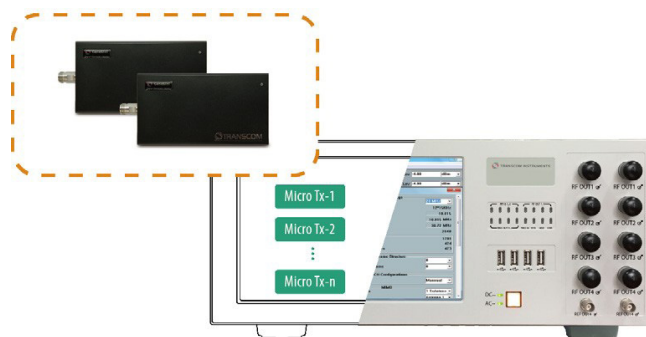
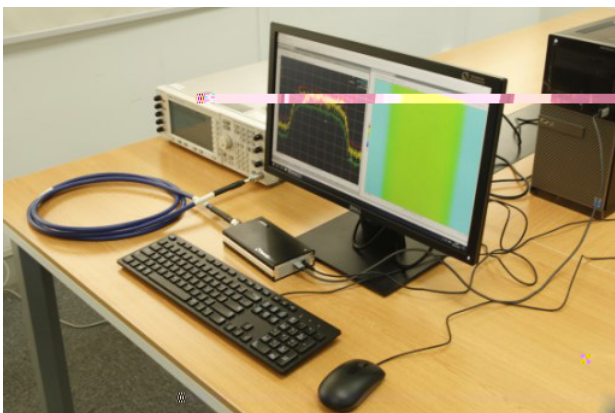

端口说明

RF 接口



Micro-TX 正面图



Micro-TX 端口连接图

技术指标

Micro-TX 技术指标	
	10MHz - 6000MHz
	0.1Hz
	± 1ppm @ 0-50
	± 0.5ppm
	-110 - +14dBm
	0.1dB
	± 0.75dB@ Lev -80dBm, ± 1.5dB@ Lev<-80dBm
	-30dBc +10dBm
	-50dBc
	-105dBc/Hz@10kHz(3-6GHz); -109dBc/Hz@10kHz(<3GHz)
	20MHz 100MHz
	I/Q
	10us-40s 10ns-40s
	BPSK QPSK OQPSK 8PSK MSK FSK 16QAM 32QAM 64QAM 128QAM 256QAM
	AM FM PM DSB USB LSB
	GSM/EDGE/TD-SCDMA/WCDMA/TDD-LTE/FDD-LTE/NB-IoT/LoRa
(LTE)	PSS SSS PSS SSS CSRS PBCH PCFICH PHICH PDCCH PDSCH PUSCH PUCCH PRACH SRS
EVM	2% rms
	± 10Hz
	± 3°
(TOI)	+15dBm (-10dBm 1MHz -10dBm)
	10MHz ± 20Hz -9dBm
	>0.9999
API	API
机械特性	
	windows10 windows7
RF	N 50
USB	USB type-C DC12V
	0° C - 50° C -20° C - 70° C
	190mm*93mm*32mm
	0.8kg

配置清单

型号	描述
T3610M	Micro-TX
标准配件	
MTX-AS001	
MTX-AS002	
选件	
MTX-S001	GSM License
MTX-S002	WCDMA License
MTX-S003	TDD-LTE License
MTX-S004	FDD-LTE License
MTX-S005	NB-IoT License
MTX-S006	LoRa License
MTX-S007	TD-SCDMA License
MTX-S008	Custom Digital Modulation License
MTX-S009	ARB License
MTX-S010	Pulse Modulation License
MTX-S011	Analog Modulation License
MTX-S012	Sweep Mode License

成为全球无线通信测试 仪器的知名品牌

关于创远

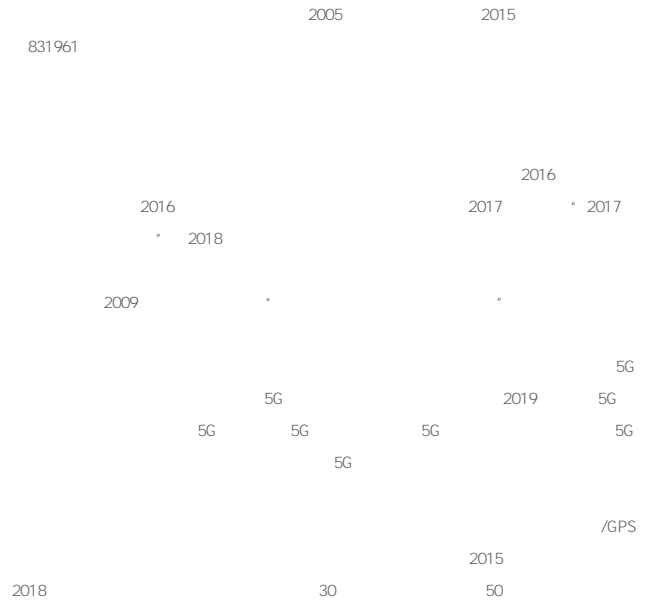

总公司

69 29 5 6
 021-6432 6888
 021-6432 6777

400-677-8077
 info@transcom.net.cn
 www.transcom.net.cn

南京分公司

9 A3 3102
 025-84937849
 025-84937849-804

西安办事处

56 B 2217
 029- 81028261

北京分公司

-7 E 403
 13817113709

深圳办事处 (筹建中)

13817170735

成都分公司

14 3 403
 028-83227390
 028-85120797

印度子公司

FF.26, Augusta Point,DLF Golf Course Road, Sector-53, Gurgaon,
 Haryana, India
 +919660656319

